

RoHS

REV.	EC#	DESCRIPTION	DATE	DRAWING	CHECKED	APPROVED
A0		NEW RELEASE	07/12'16	DW		---

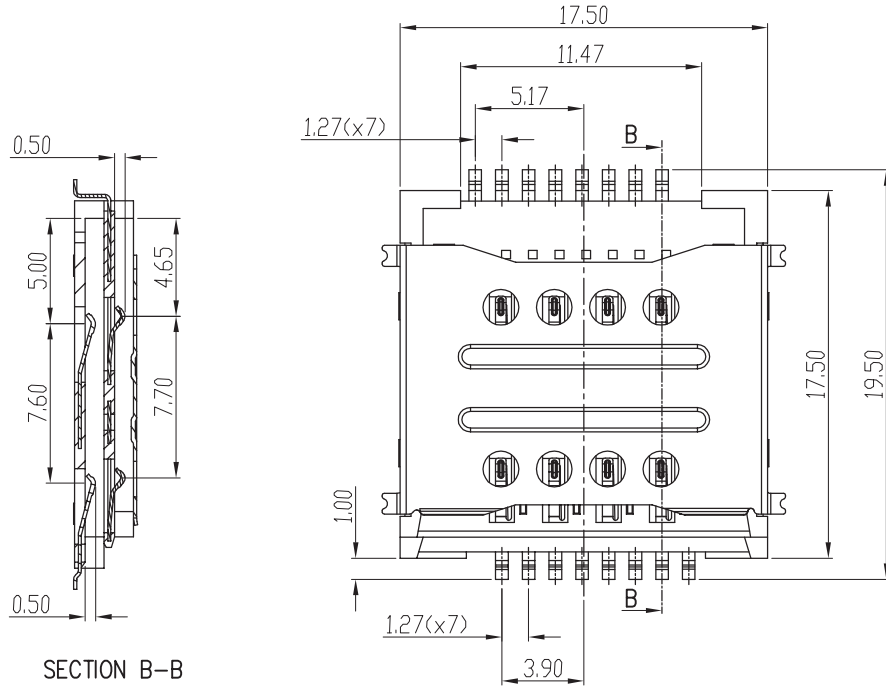

SECTION B-B

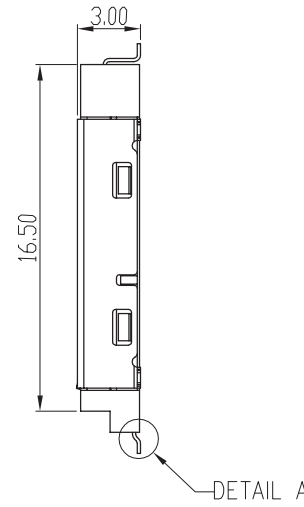
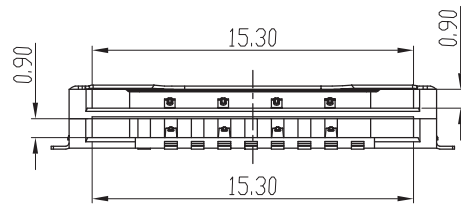

DETAIL A

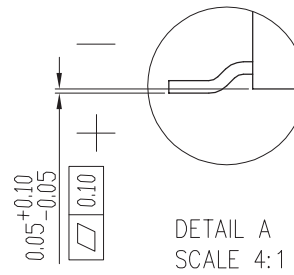
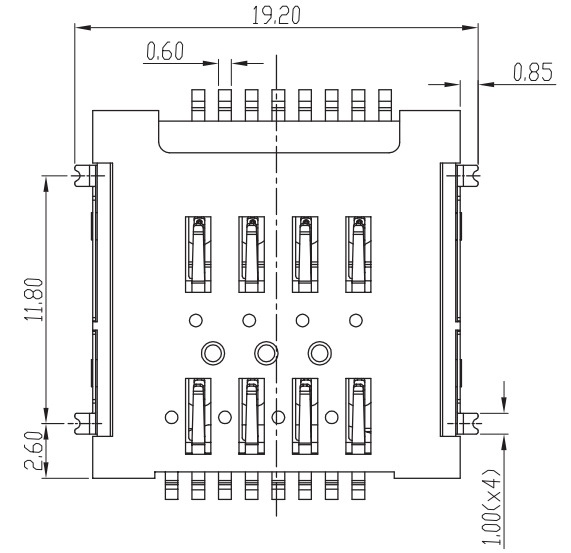

DETAIL A
SCALE 4:1

PART No.:

SIM-S102012912

CARD SERIES

PLATING:

01:G/F

PAKING:

2: REEL

SERIAL NO.

Se Seconn International Enterprise Co., Ltd.

TOLERANCES		PROJECTION	TITLE			
x.x	= ± 0.38		SIM Card Connector H: 3.0mm Double Type			
x.xx	= ± 0.25					
x.xxx	= ± 0.10					
Angles ± 2°		UNIT				
		mm				
DRAWN	DW	DATE	2016/07/12	PART NO.	SIM-S102012912	
SCALE	1:1	SIZE	A4	SHEET	1/3	REV A0

RoHS

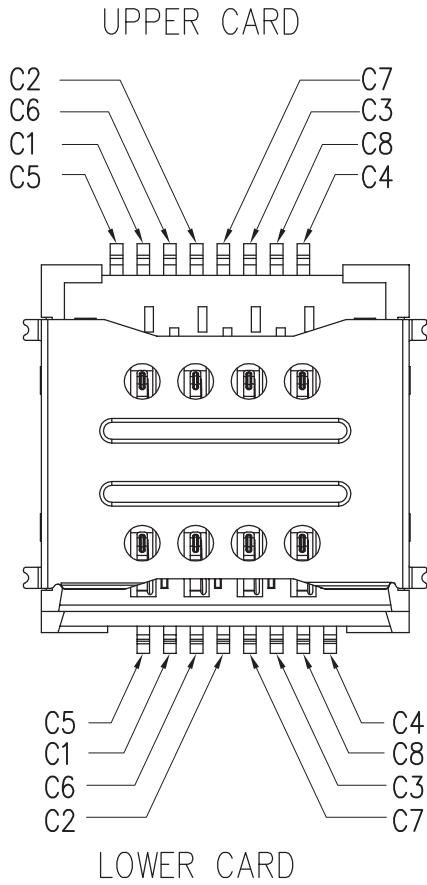

C1	C1: VCC
C2	C2: RST
C3	C3: CLK
C4	C4: RESERVED
C5	C5: GND
C6	C6: VPP
C7	C7: I/O
C8	C8: RESERVED

SIM CARD CIRCUIT

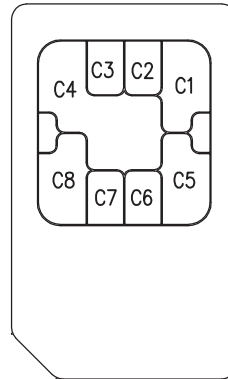

- NOTES:
- MATERIAL:
 - Housing: HI-TEMP Plastic,UL94V-0,Black;
 - Terminal: C5210,
 - Shell: SUS201,
 - FINISH:
 - Terminal: Au Plated on the contact area,Matte tin plated on the solder tails underplated over nickel;
 - Shell: Au plated on the solder tails underplated over nickel;
 - Electrical Performance:
 - Current Rating: 1A
 - Voltage Rating: 50V RMS.
 - Contact Resistance: 50mΩ Max
 - Dielectric Withstanding Voltage: 500V AC for 1 minute
 - Insulation Resistance: 1000 MΩ Min
 - Mechanical Performance:
 - Durability: 3000 cycles;
 - Normal force: 20gf/PIN Min;

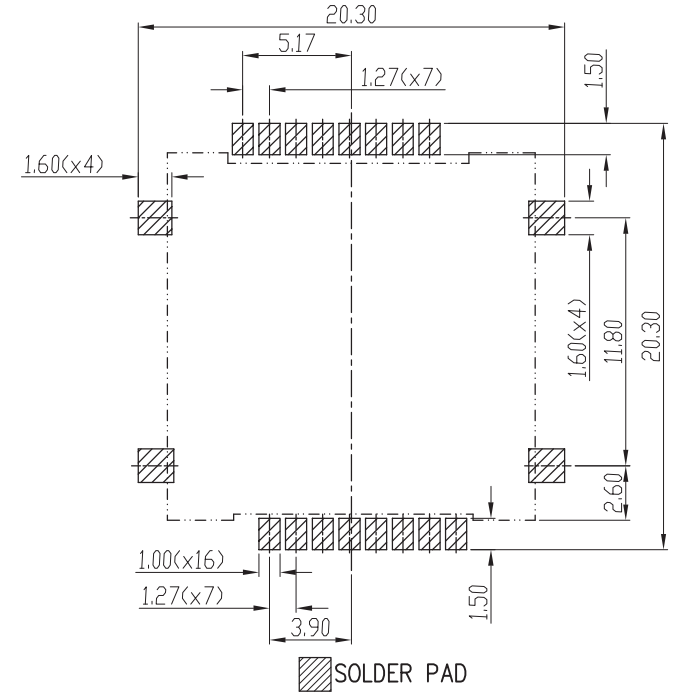

RECOMMENDED PCB LAYOUT TOLERANCE: ±0.05

Seconn International Enterprise Co., Ltd.

TOLERANCES		PROJECTION	TITLE				
x.x	= ± 0.38		SIM Card Connector H: 3.0mm Double Type				
x.xx	= ± 0.25						
x.xxx	= ± 0.10						
Angles ± 2°		UNIT					
		mm					
DRAWN	D W	DATE	2016/07/12	PART NO.	SIM-S102012912		
SCALE	1:1	SIZE	A4	SHEET	2/3	REV	A0

RoHS

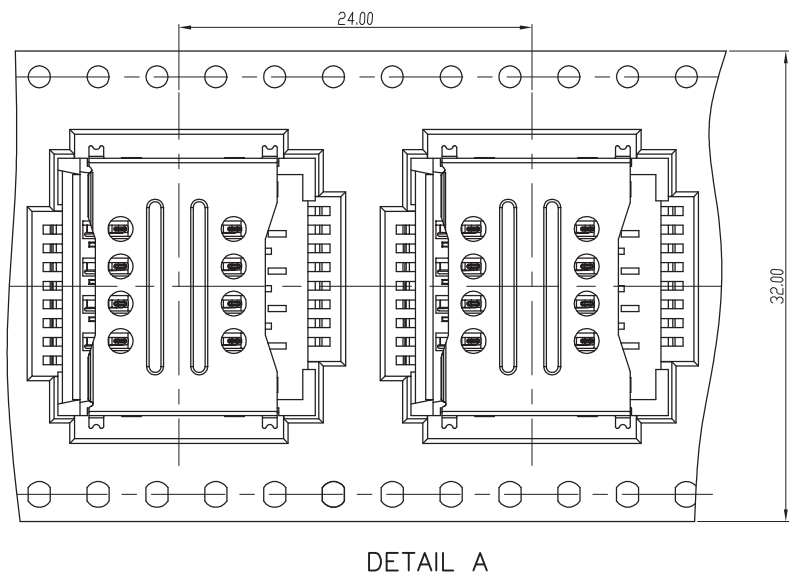
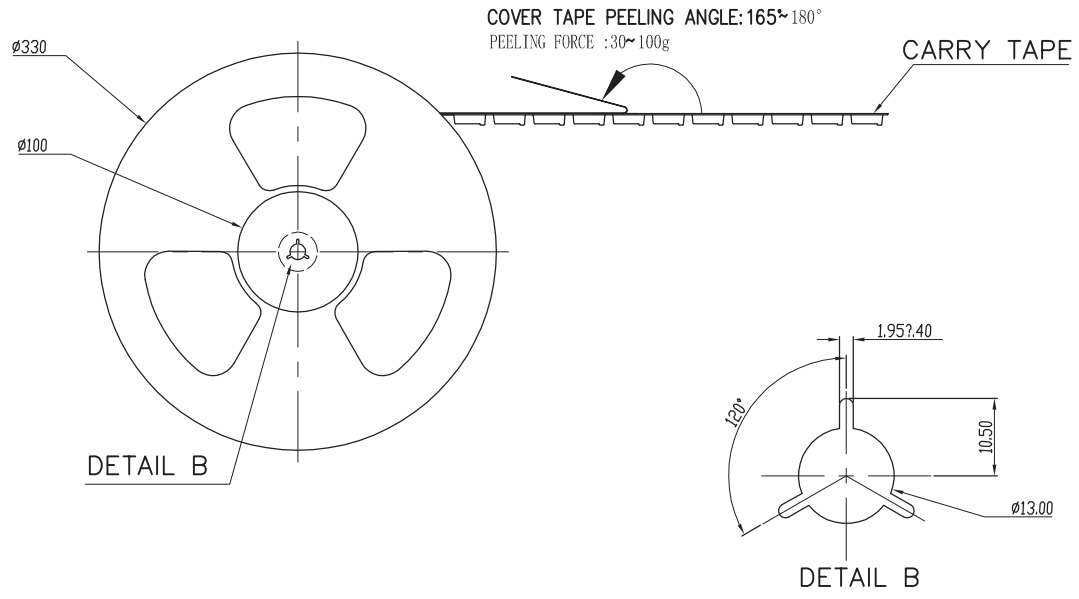
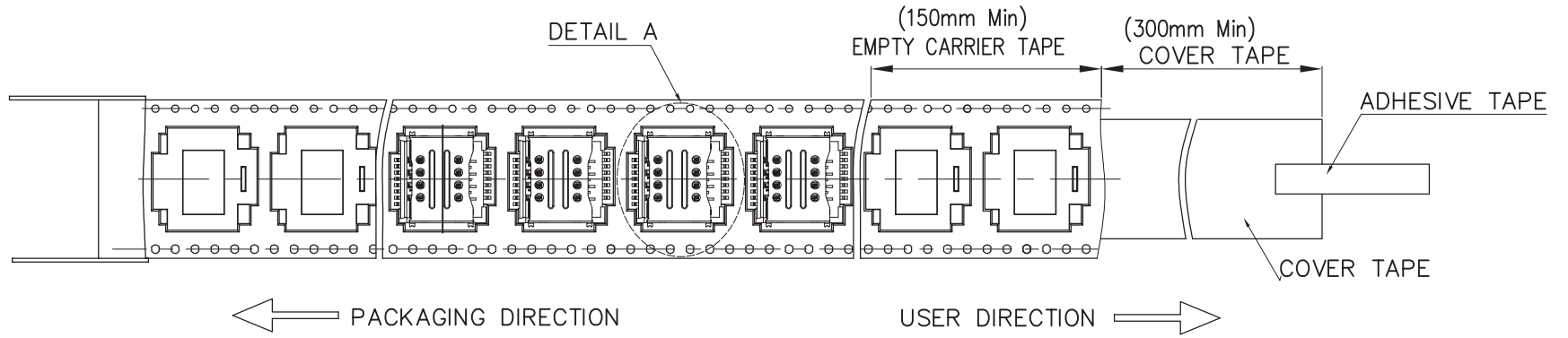

1	102012912	700	9	6300	345X345X352
ITEM	R/N.	QTY/REEL	REEL/CARTON	QTY/CARTON	CARTON SIZE

Seconn International Enterprise Co., Ltd.

TOLERANCES			PROJECTION	TITLE			
x.x	= ± 0.38		 UNIT mm	SIM Card Connector H: 3.0mm Double Type			
x.xx	= ± 0.25						
Angles ± 2°							
x.xxx	= ± 0.10						
DRAWN	DW	DATE	2016/07/12	PART NO.	SIM-S102012912		
SCALE	1:1	SIZE	A4	SHEET	3/3	REV	A0